



Istvan David



Eugene Syriani

Département d'informatique et de recherche opérationnelle
Université de Montréal

istvan.david@umontreal.ca



REAL-TIME COLLABORATIVE MODELING

REAL-TIME COLLABORATIVE MODELING

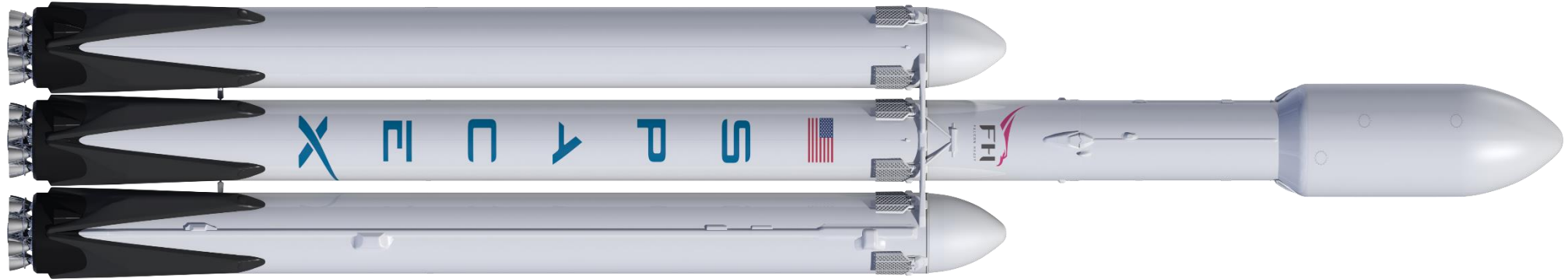

REAL-TIME COLLABORATIVE MODELING

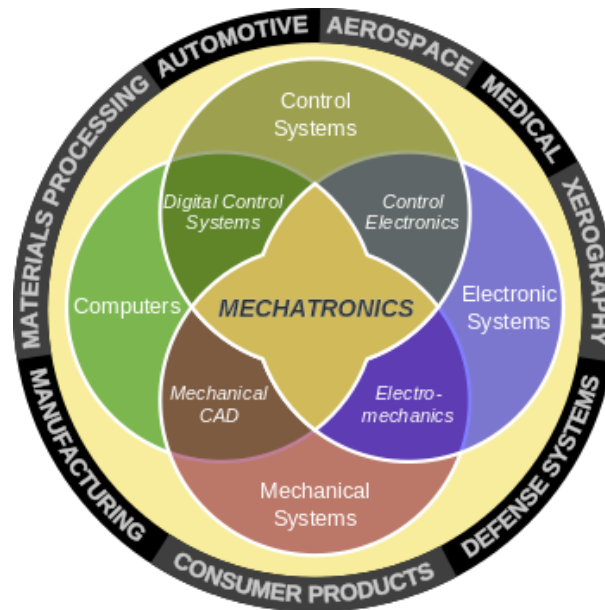
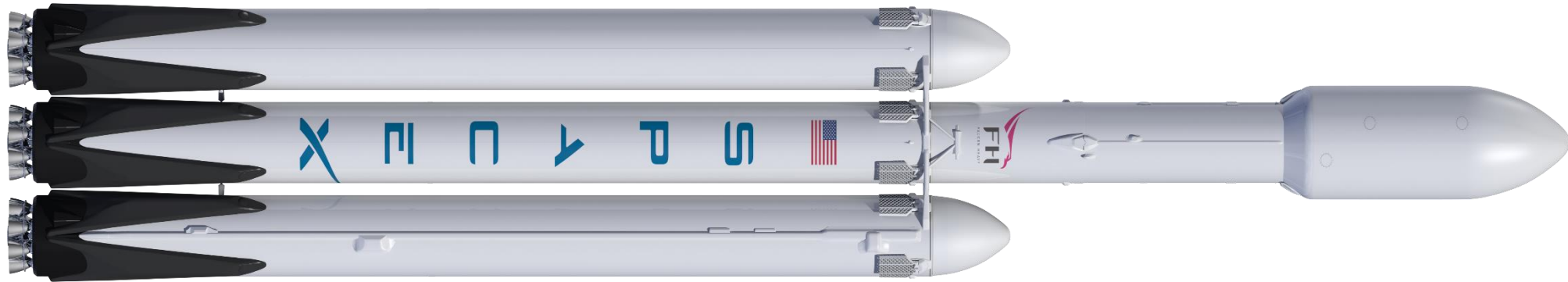

REAL-TIME COLLABORATIVE MODELING

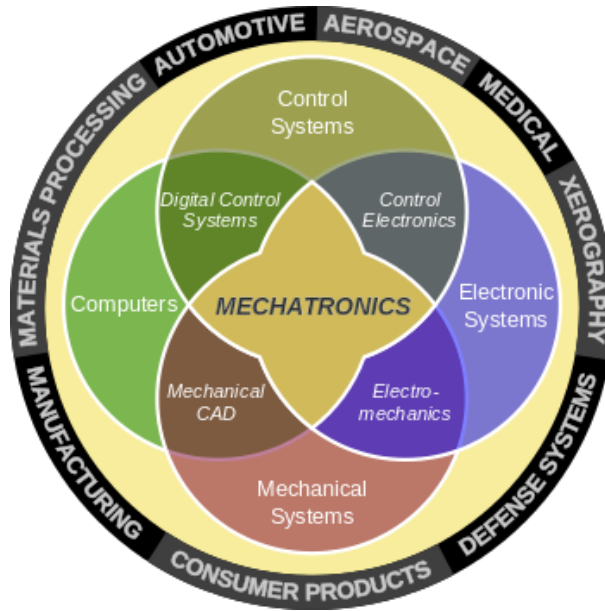
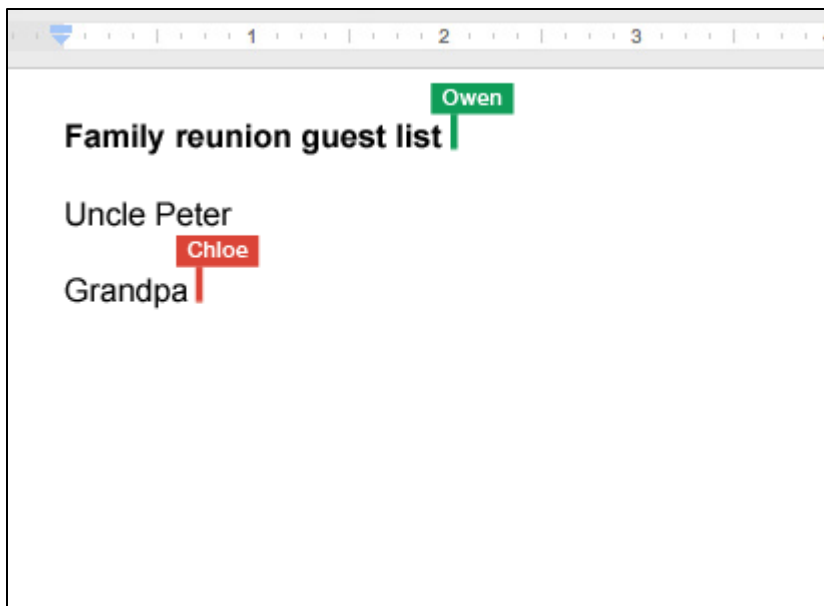
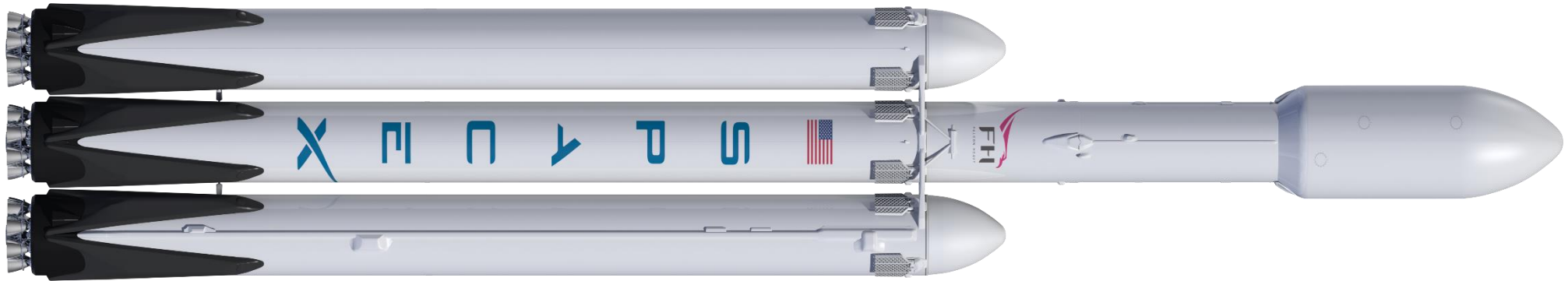

REAL-TIME COLLABORATIVE MODELING BY CONFLICT-FREE REPLICATED DATA TYPES

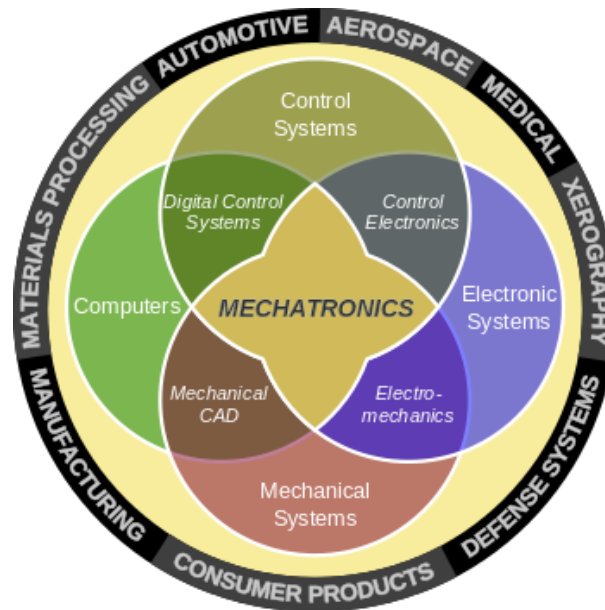
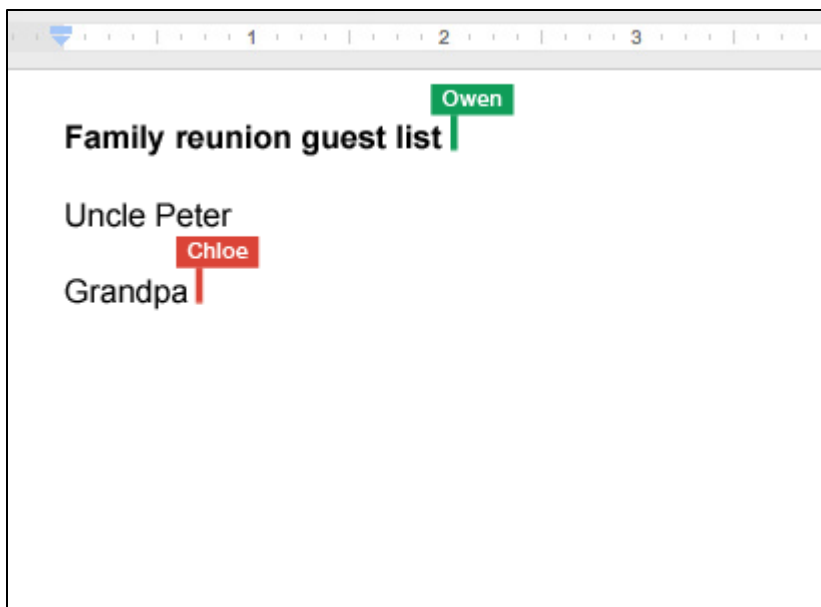

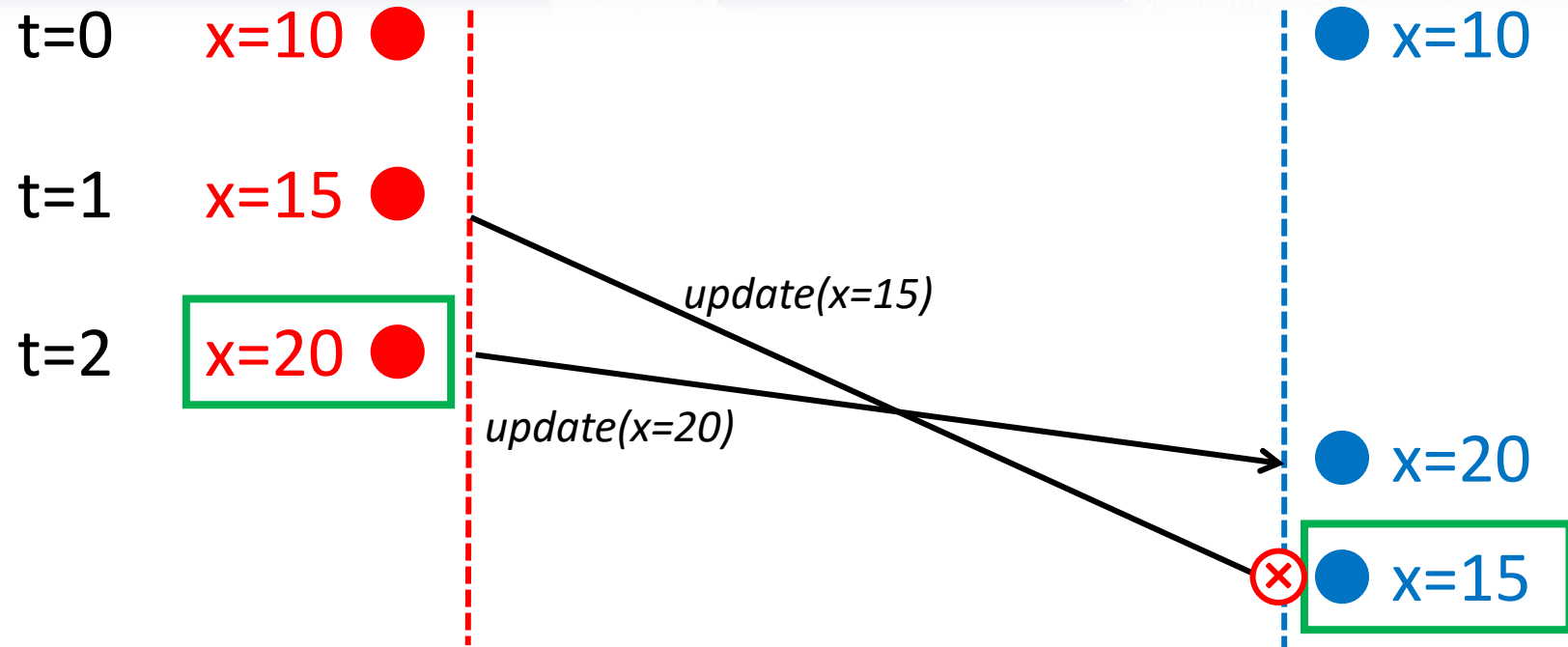

Conflict-free replicated data types (CRDT)

- Sound algebraic framework
- Operation-based CRDT
 - Concurrent operations are commutative
- State-based CRDT
 - Structured in a way that they adhere to a monotonic semi-lattice

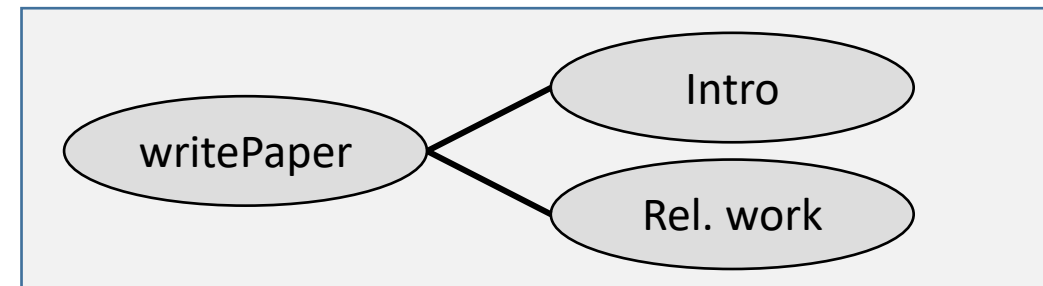
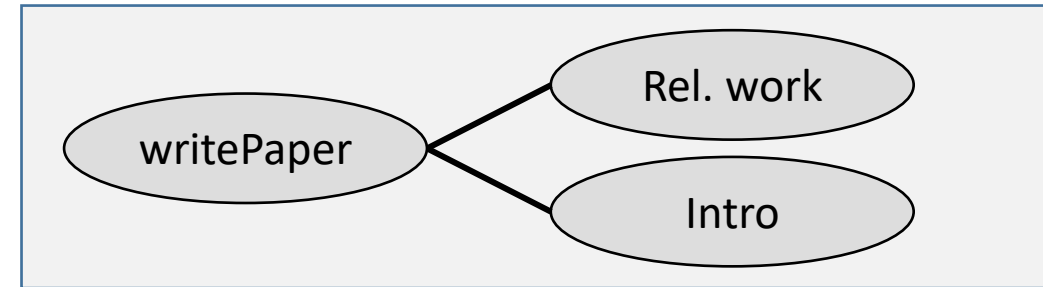
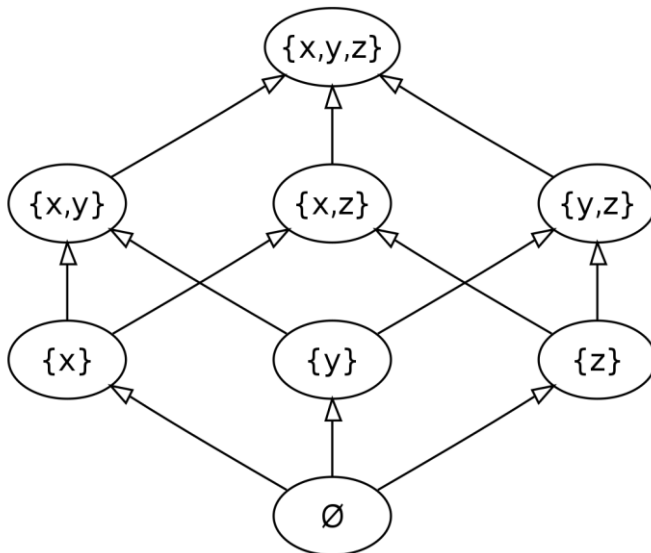
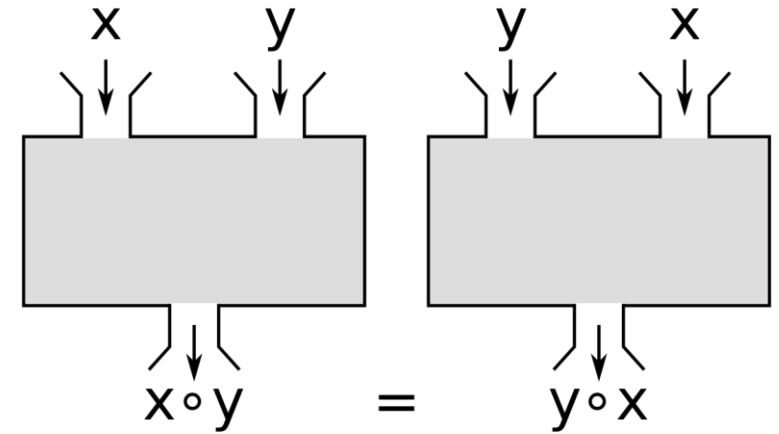

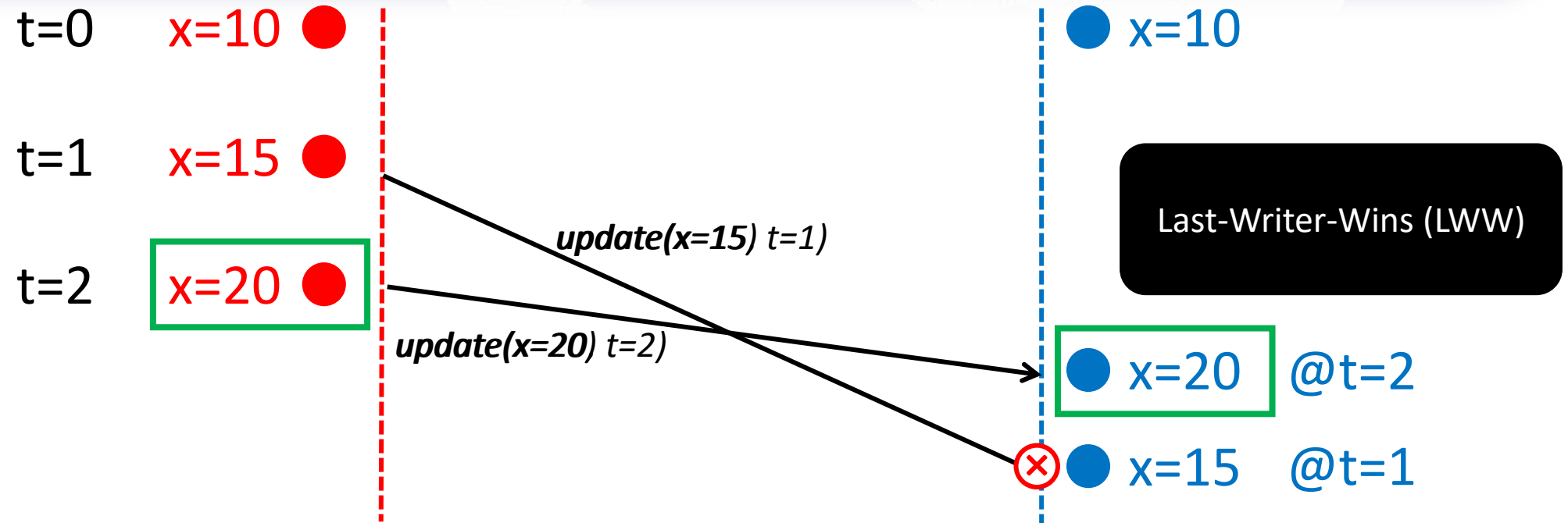

Conflict-free replicated data types (CRDT)

- Sound algebraic framework
- Operation-based CRDT
 - Concurrent operations are commutative
- State-based CRDT
 - Structured in a way that they adhere to a monotonic semi-lattice

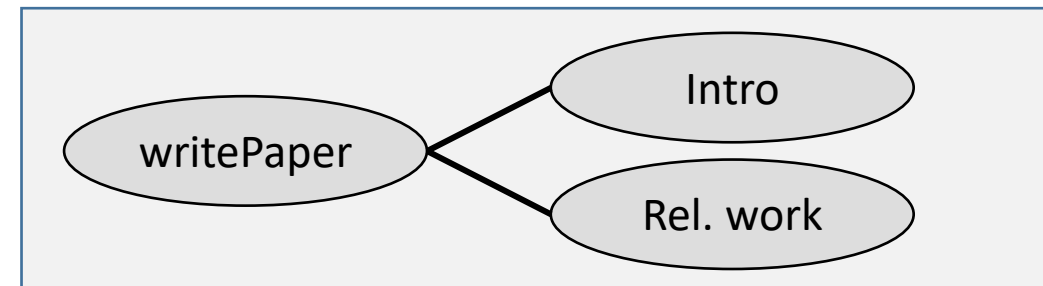
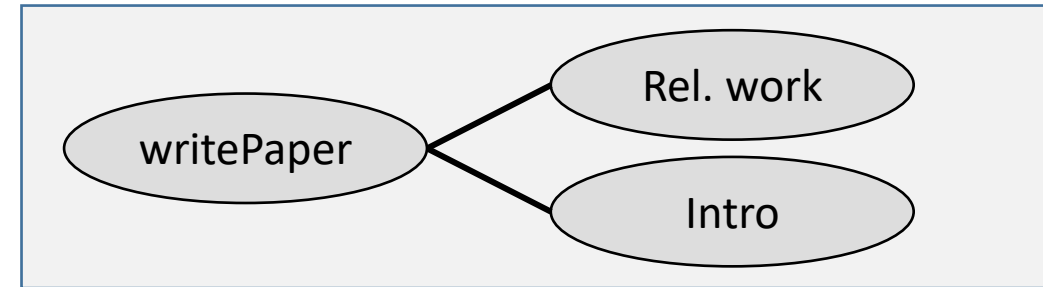
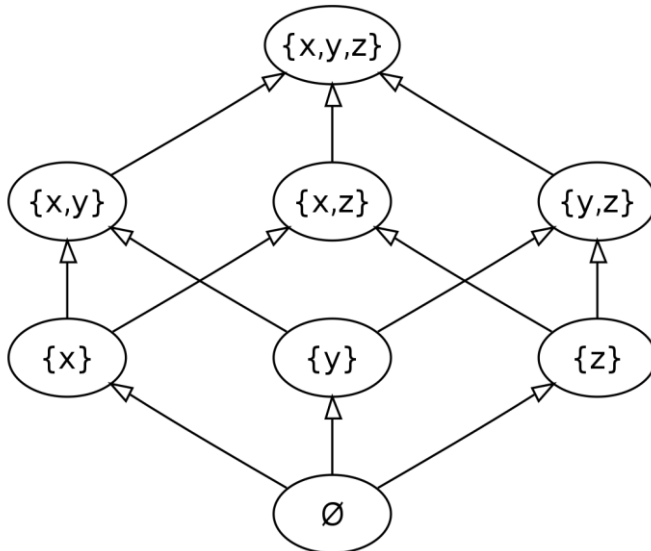
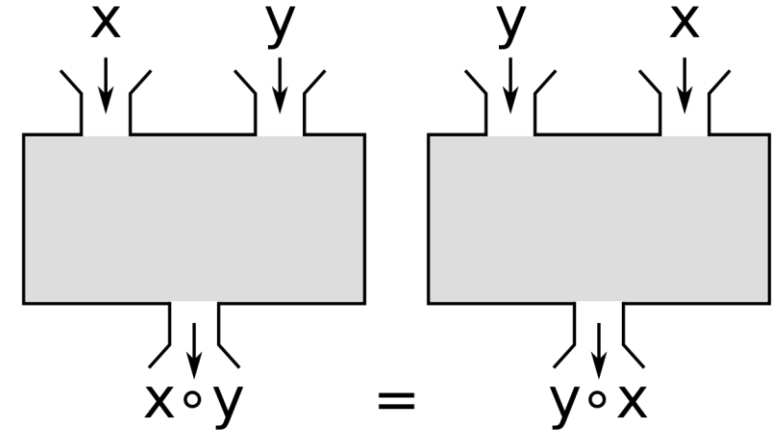

Conflict-free replicated **data types** (CRDT)

- Sound algebraic framework
- Operation-based CRDT
 - Concurrent operations are commutative
- State-based CRDT
 - Structured in a way that they adhere to a monotonic semi-lattice

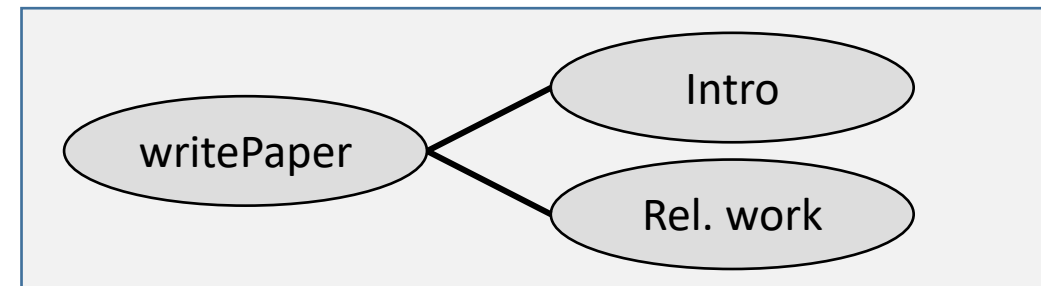
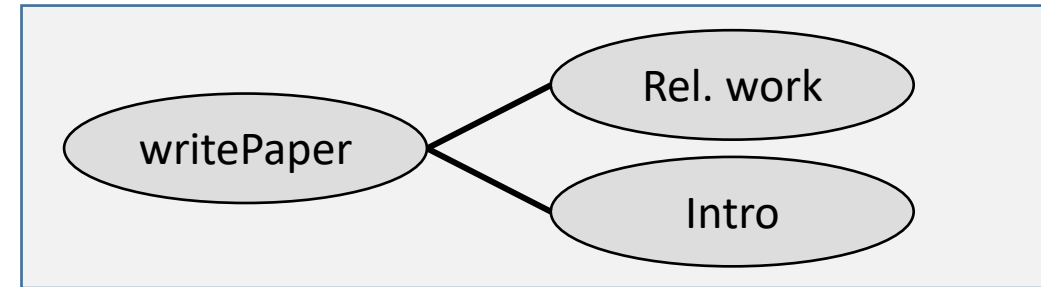
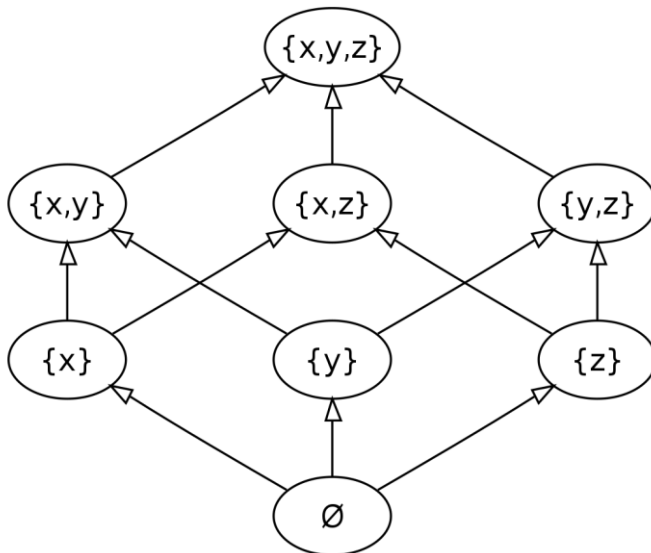
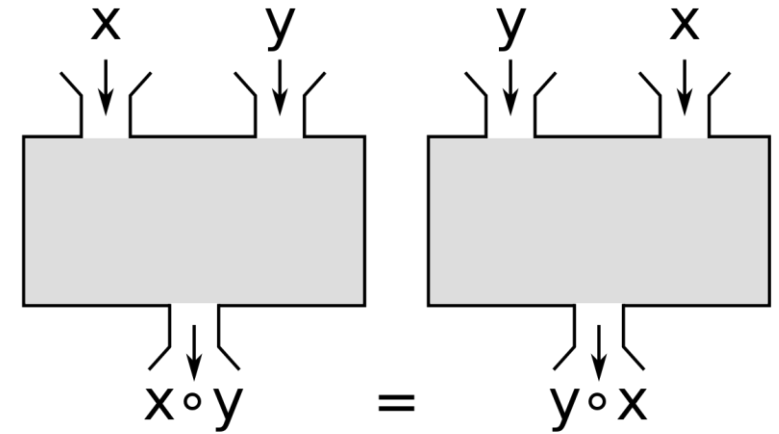

- A low-level and transparent framework for collaborative modeling
- <https://github.com/geodes-sms/lowkey>

Lowkey

1) Secretly or discretely

2) Slightly or kinda

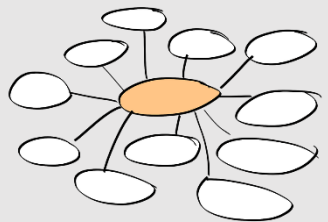

```
Mindmap myTasks
Task publishPaper
  Subtask drawFigures
Task organizeResearchDay
  Subtask nagPeople
```

Collab. type system

Collab. type system

OMQ

lowkey

- A low-level and transparent framework for collaborative modeling
- <https://github.com/geodes-sms/lowkey>

1) Secretly or discretely

2) Slightly or kinda

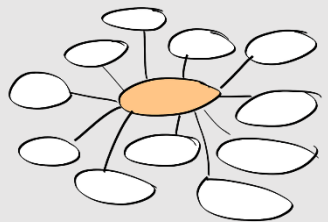

```
Mindmap myTasks
Task publishPaper
Subtask drawFigures
Task organizeResearchDay
Subtask nagPeople
```

Collab. type system

Collab. type system

OMQ

lowkey

CRDT

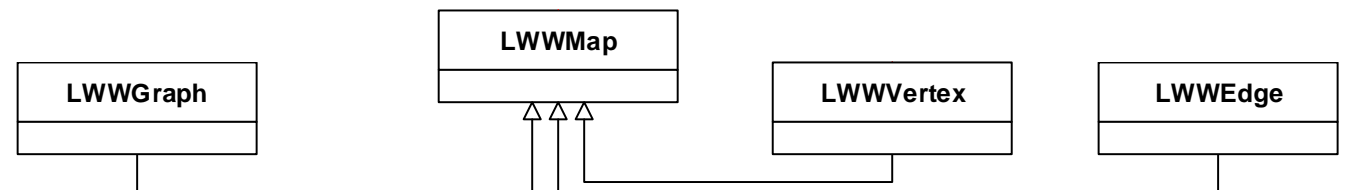

- A low-level and transparent framework for collaborative modeling
- <https://github.com/geodes-sms/lowkey>

Lowkey

1) Secretly or discretely

2) Slightly or kinda

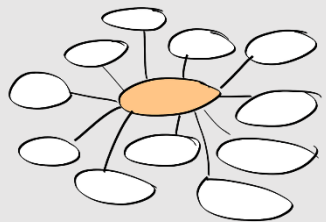

Mindmap myTasks
 Task publishPaper
 Subtask drawFigures
 Task organizeResearchDay
 Subtask nagPeople

Collab. type system

Collab. type system

OMQ

lowkey

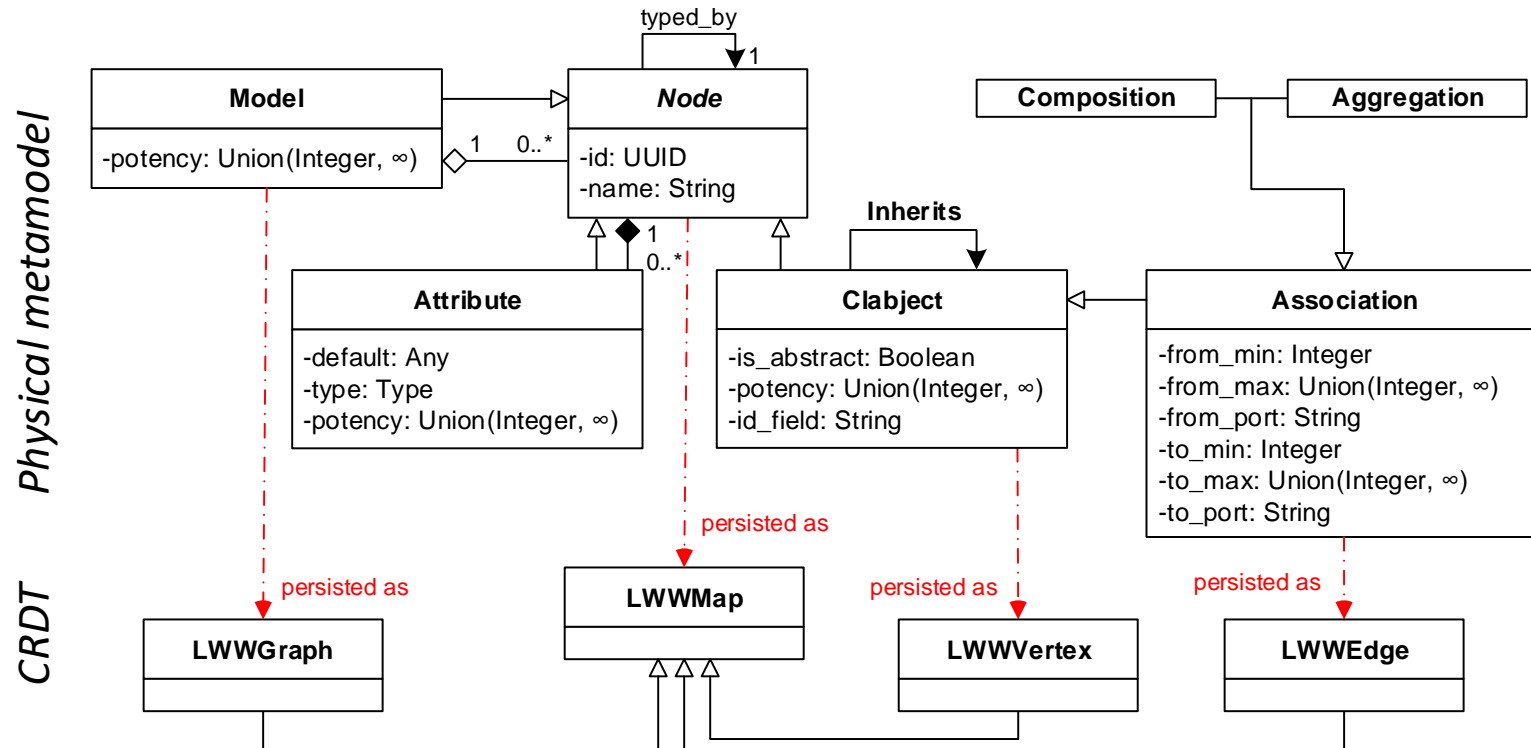

- A low-level and transparent framework for collaborative modeling
- <https://github.com/geodes-sms/lowkey>

Lowkey

- 1) Secretly or discretely
- 2) Slightly or kinda

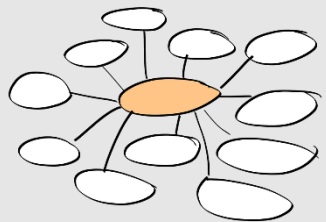

Mindmap myTasks
 Task publishPaper
 Subtask drawFigures
 Task organizeResearchDay
 Subtask nagPeople

Collab. type system

Collab. type system

OMQ

lowkey

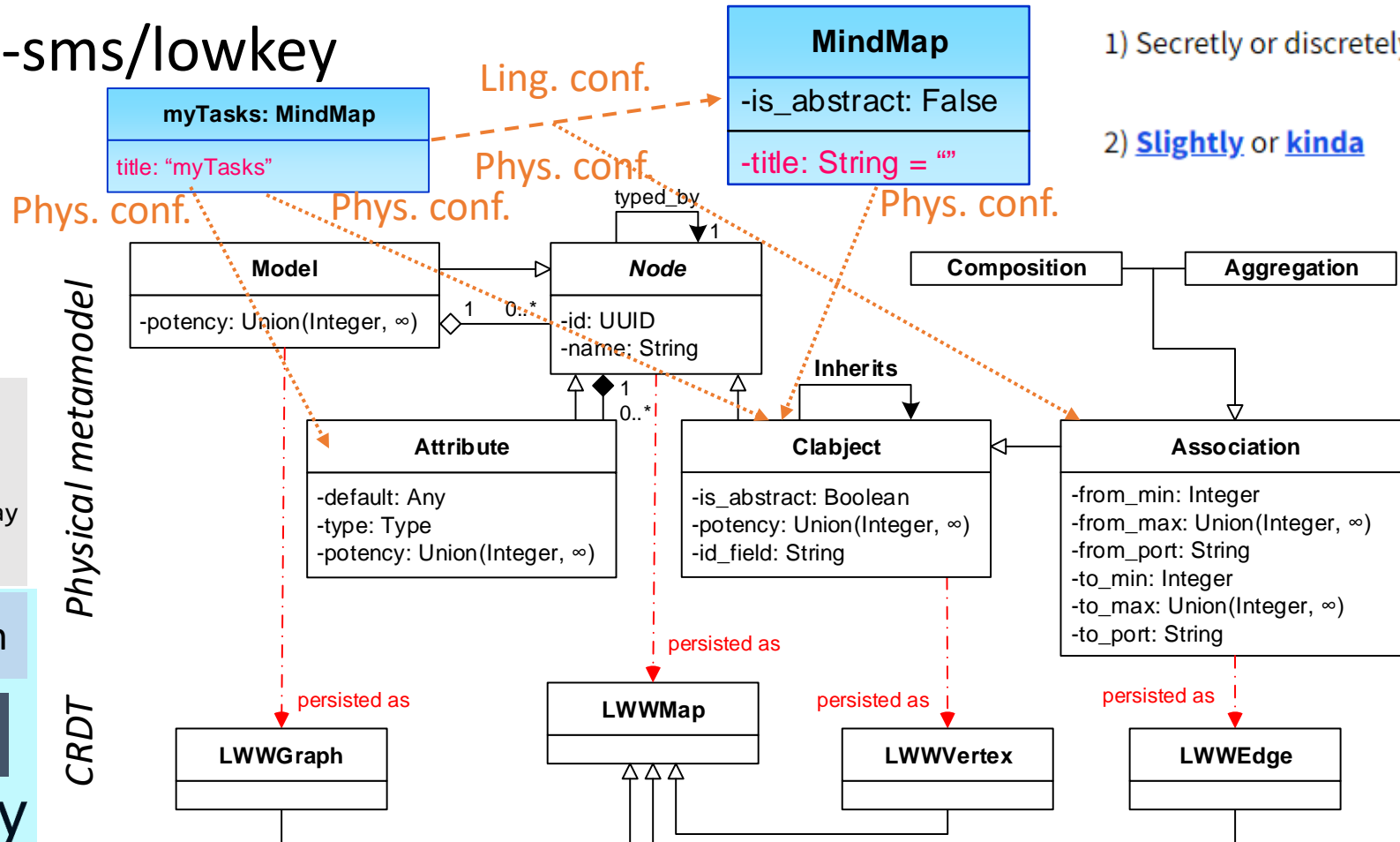

Ongoing/future work



Human-machine collaboration

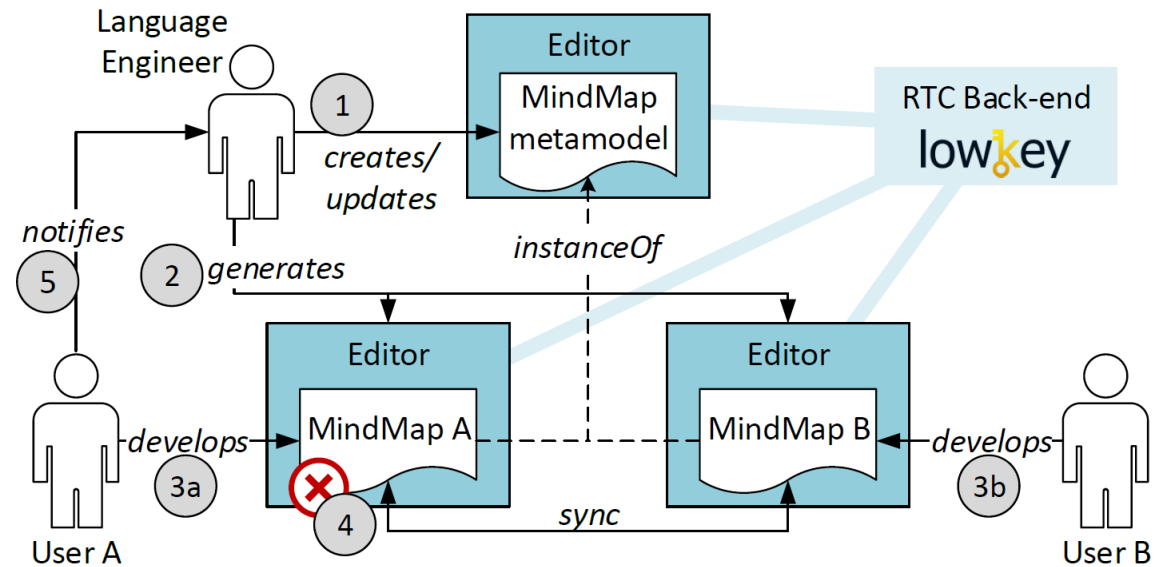

Model-Language Co-evolution
by Multi-level Real-time Collaboration